

Part No.

AL-314W1C

Diff No.

3 mm

Round

Type : LED Lamps

Package Dimension :

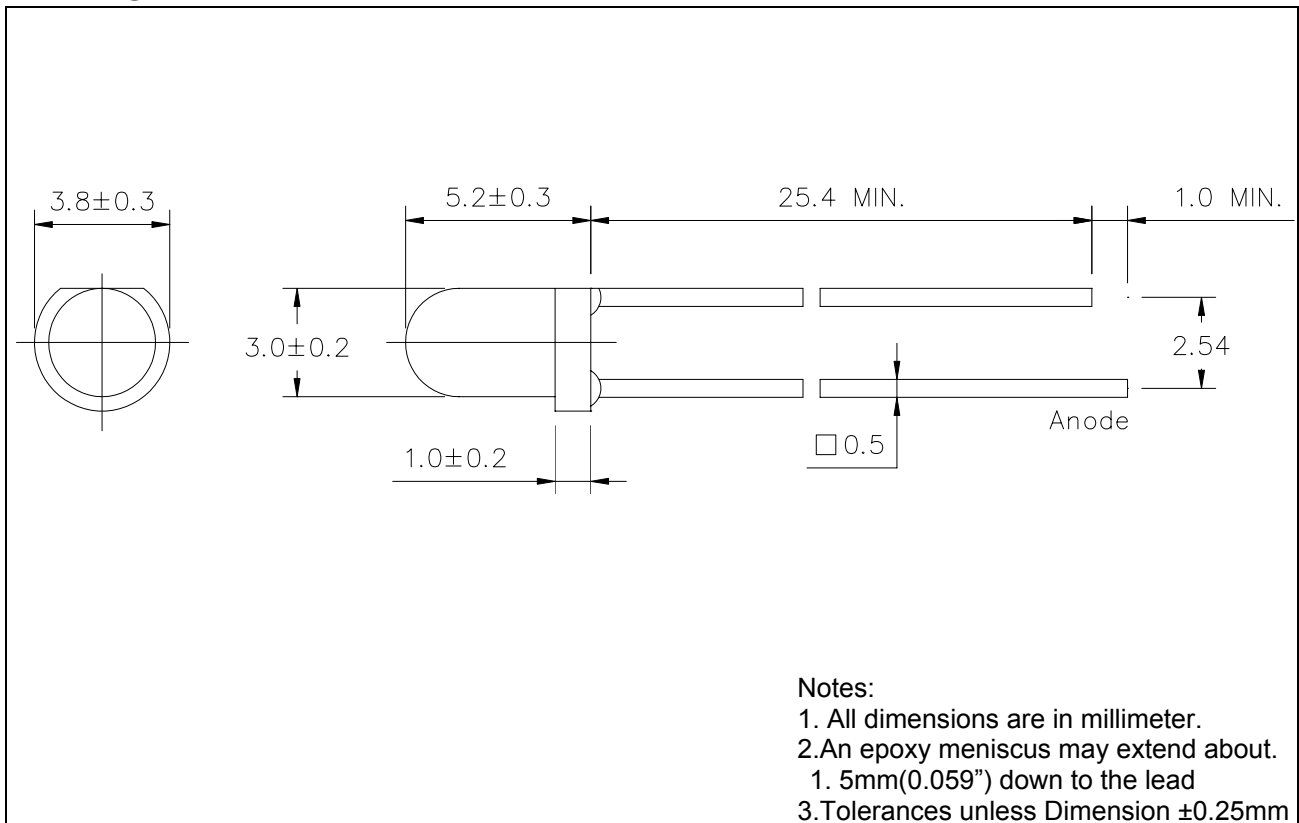

■ Features :

- Choice of various viewing angles.
- Available on Tape and Reel.
- Reliable and robust.

■ Descriptions :

- The series is specially designed for application requiring higher brightness.
- The LED lamps are available with different colors, intensity, epoxy colors etc.

■ Applications :

- TV set
- Monitor
- Telephone

Part No.

AL-314W1C

Diff No.

3 mm

Round

Type : LED Lamps

PART NO.	Chip		Lens Color
	Material	Emitted Color	
AL-314W1C	InGaN	White	Water Clear

■ Absolute Maximum Ratings at Ta=25°C

Parameter	Symbol	Rating	Unit
Forward Current	I _F	30	mA
Operating Temperature	T _{opr}	-40 to +85	°C
Storage Temperature	T _{stg}	-40 to +85	°C
Soldering Temperature	T _{sol}	260 ±5	°C
Electrostatic Discharge	ESD	1000	V
Power Dissipation	P _D	120	mW
Peak Forward Current (Duty 1/10@1KHz)	I _F (Peak)	100	mA
Reverse Voltage	V _R	5	V

■ Electronic Optical Characteristics :

Parameter	Symbol	Min.	Typ.	Max.	Unit	Condition
Luminous Intensity	I _v	1400	2000	/	mcd	I _F =20mA
Viewing Angle	2θ _{1/2}	/	15	/	deg	I _F =20mA
Chromaticity Coordinates	X	/	0.31	/	/	I _F =20mA
	Y	/	0.32	/	/	I _F =20mA
Forward Voltage	V _F	/	3.2	3.5	V	I _F =20mA
Reverse Current	I _R	/	/	50	μA	V _R =5V

Part No.

AL-314W1C

Diff No.

3 mm

Round

Type : LED Lamps

■ Reliability test items and conditions :

NO	Item	Test Conditions	Test Hours/Cycle	Sample Size	Ac/Re
1	Solder Heat	TEMP : 260°C ± 5°C	5 SEC	76 PCS	0/1
2	Temperature Cycle	H : +85°C 30min ┆ 5min L : -55°C 30min	50 CYCLES	76 PCS	0/1
3	Thermal Shock	H : +100°C 5min ┆ 10set L : -10°C 5min	50 CYCLES	76 PCS	0/1
4	High Temperature Storage	TEMP : 100°C	1000 HRS	76 PCS	0/1
5	Low Temperature Storage	TEMP : -55°C	1000 HRS	76 PCS	0/1
6	DC Operating Life	TEMP : 25°C I _F =20mA	1000 HRS	76 PCS	0/1
7	High Temperature / High Humidity	85°C / 85%RH	1000 HRS	76 PCS	0/1

Part No.

AL-314W1C

Diff No.

3 mm

Round

Type : LED Lamps

■ Color Ranks

Rank a				
x	0.280	0.264	0.283	0.296
y	0.248	0.267	0.305	0.276

Approximate Color Temperature : 6500-10000K

Rank b1				
x	0.287	0.283	0.330	0.330
y	0.295	0.305	0.360	0.339

Approximate Color Temperature : 5500-6500K

Rank b2				
x	0.296	0.287	0.330	0.330
y	0.276	0.295	0.339	0.318

Approximate Color Temperature : 5500-6500K

Rank C				
x	0.330	0.330	0.361	0.356
y	0.318	0.360	0.385	0.351

Approximate Color Temperature : 4500-5500K

■ CIE Chromaticity Diagram

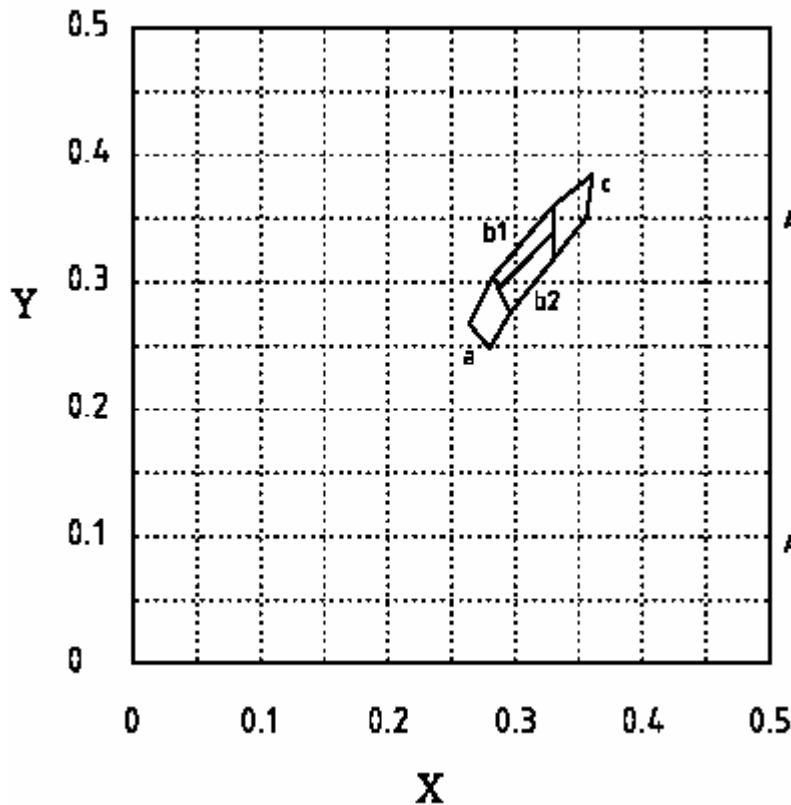

Part No.
3 mm

AL-314W1C
Round

Diff No.
Type : LED Lamps

◆ TYPICAL ELECTRICAL-OPTICAL CHARACTERISTICS CURVES

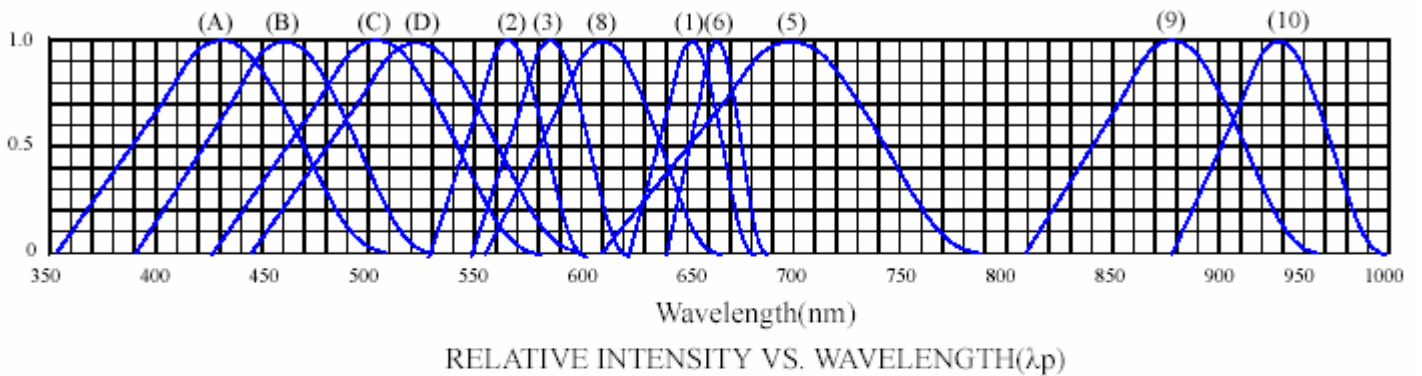
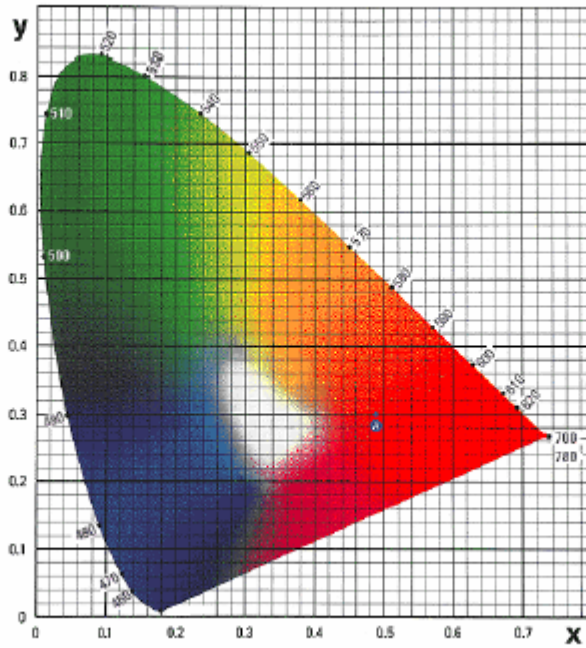

- (1) GaAsP/GaAs 655nm/Red
- (2) GaP 568nm/ Yellow Green
- (3) GaAsP/GaP 585nm/Yellow
- (4) GaAsP/GaP 635nm/Orange & Hi-Eff Red
- (5) GaP 700nm/Bright Red
- (6) GaAlAs/GaAs 660nm/Super Red
- (8) GaAsP/GaP 610nm/Super Red

- (9)- GaAlAs 880nm
- (10)-GaAs/GaAs&GaAlAs/GaAs 940nm
- (A)- GaN 430nm/Blue
- (B)- InGaN 470nm/Blue
- (C)- InGaN 502nm/Ultra Green
- (D)- InGaN 523nm/Ultra Green

Part No.

AL-314W1C

Diff No.

3 mm

Round

Type : LED Lamps

◆ CHARACTERISTICS DIAGRAMS

FORWARD CURRENT VS. FORWARD VOLTAGE

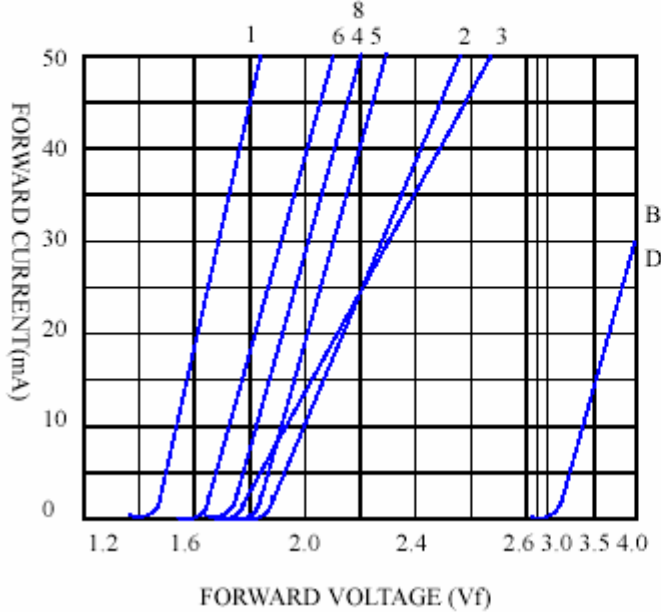

RELATIVE LUMINOUS INTENSITY VS. FORWARD CURRENT

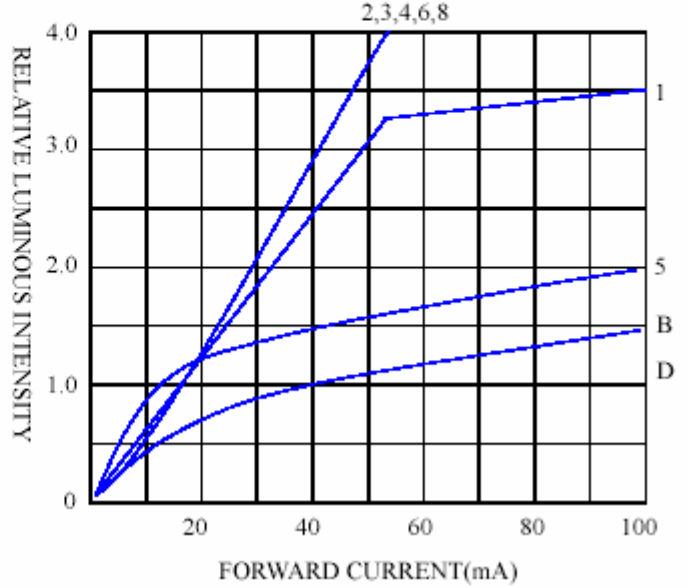

FORWARD CURRENT VS. AMBIENT TEMPERATURE

