

A-BRIGHT A-BRIGHT INDUSTRIAL CO., LTD. SURFACE MOUNT CHIP LED LAMPS

TOP View LEDs

Part Number: 67-21SUGC

Package outlines & Re-flow Profile

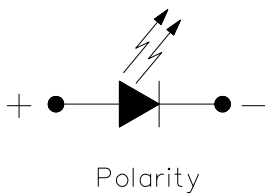
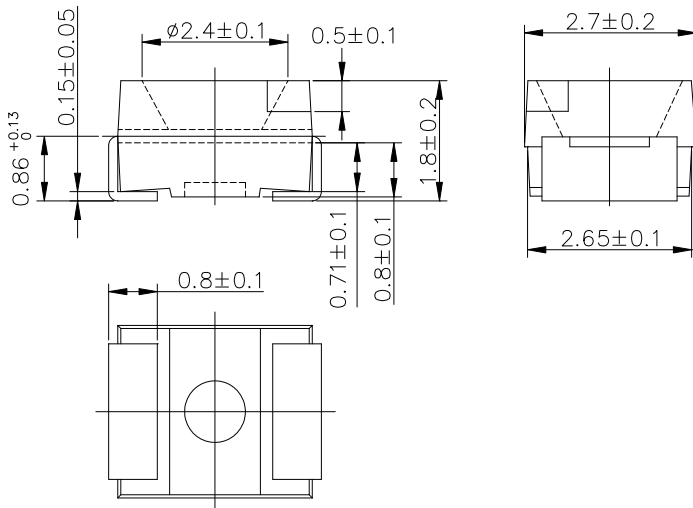
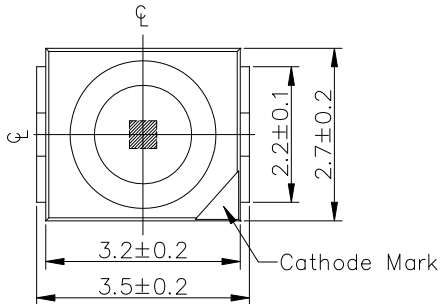

For Reflow Soldering

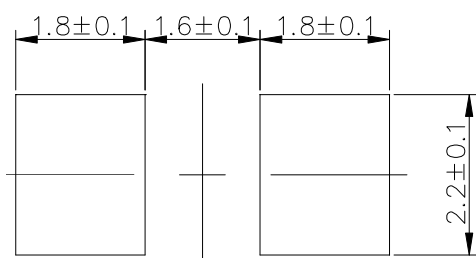

■ Reflow Temp/Time

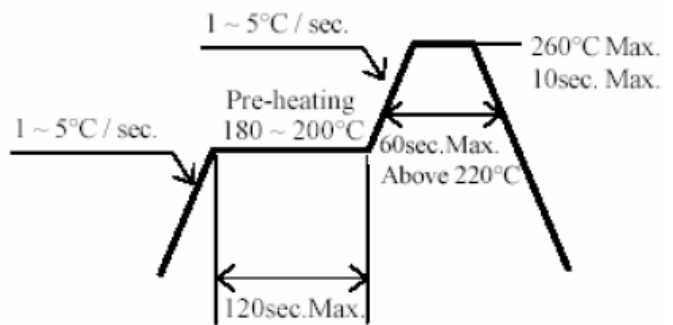

■ Soldering iron

Basic spec is $\leq 5\text{sec}$ when 260°C . If temperature is higher, time should be shorter ($+10^\circ\text{C} \rightarrow -1\text{sec}$). Power dissipation of iron should be smaller than 15W , and temperatures should be controllable. Surface temperature of the device should be under 230°C .

ITEM	MATERIALS
Resin (mold)	Epoxy
Lens color	Water Clear
Printed circuit board	BT
Material	InGaN
Emitted color	Super Green

NOTES:

1. All dimensions are in millimeters (inches).
2. Tolerances are $\pm 0.1\text{mm}$ (0.004inch) unless otherwise noted.
3. Polarity referring onto the cathode mark is reversed on the red.

A-BRIGHT A-BRIGHT INDUSTRIAL CO., LTD. SURFACE MOUNT CHIP LED LAMPS

Part Number: 67-21SUGC

ELECTRO-OPTICAL CHARACTERISTICS (T_A=25°C)

Parameter	Test Condition	Symbol	Value			Unit
			MIN.	TYP.	MAX.	
Forward voltage	I _F =20mA	V _F	—	3.2	3.5	V
Luminous intensity	I _F =20mA	I _v	—	280	—	mcd
Peak Wavelength	I _F =20mA	λ _p	—	530	—	nm
Dominant Wavelength	I _F =20mA	λ _d	—	525	—	nm
Spectral Line Half-Width	I _F =20mA	Δλ	—	35	—	nm
Peak pulsing current (1/10 duty f=1kHz)		I _{FP}		100		mA
Power Dissipation		P _D		110		mW
Reverse current	V _R =5V	I _R		50		μA
Electrostatic Discharge		ESD		150		mA

Absolute maximum ratings (T_A=25°C)

Parameter	Symbol	Value	Unit
Viewing angle at 50% I _v	2θ _{1/2}	120	Deg
Forward current	I _F	25	mA
Reverse voltage	V _R	5	V
Operating temperature range	Top	-40 ~ +85	°C
Storage temperature range	Tstg	-40 ~ +100	°C

A-BRIGHT A-BRIGHT INDUSTRIAL CO., LTD.
SURFACE MOUNT CHIP LED LAMPS

Part Number: 67-21SUGC

Test items and results of reliability

NO	Item	Test Conditions	Test Hours/Cycle	Sample Size	Ac/Re
1	Reflow	TEMP : 240±5°C Min. 5sec.	6 MIN.	22 PCS	0/1
2	Temperature Cycle	H : +100°C 15min ∫ 5min L : -40°C 15min	300 CYCLES	22 PCS	0/1
3	Thermal Shock	H : +100°C 5min ∫ 10set L : -10°C 5min	300 CYCLES	22 PCS	0/1
4	High Temperature Storage	TEMP : 100°C	1000 HRS	22 PCS	0/1
5	Low Temperature Storage	TEMP : -55°C	1000 HRS	22 PCS	0/1
6	DC Operating Life	I _F =20mA	1000 HRS	22 PCS	0/1
7	High Temperature / High Humidity	85°C / 85%RH	1000 HRS	22 PCS	0/1

* Refer to reliability test standard specification for in this line.

SURFACE MOUNT CHIP LED LAMPS

Part Number: 67-21SUGC

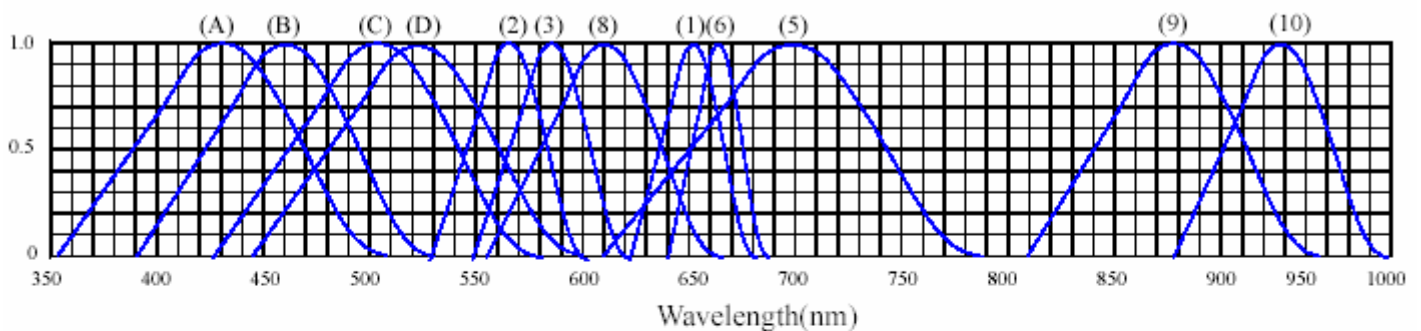
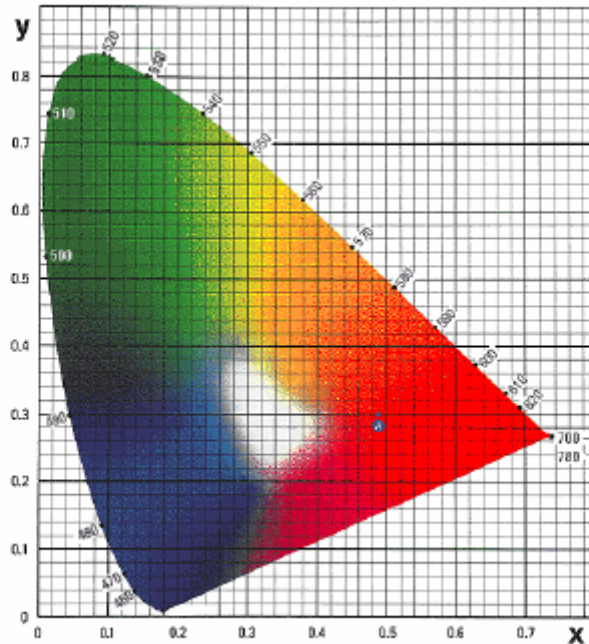
Typical Electro-Optical Characteristics◆ **TYPICAL ELECTRICAL-OPTICAL CHARACTERISTICS CURVES**RELATIVE INTENSITY VS. WAVELENGTH(λ_p)

- (1) GaAsP/GaAs 655nm/Red
- (2) GaP 568nm/ Yellow Green
- (3) GaAsP/GaP 585nm/Yellow
- (4) GaAsP/GaP 635nm/Orange & Hi-Eff Red
- (5) GaP 700nm/Bright Red
- (6) GaAlAs/GaAs 660nm/Super Red
- (8) GaAsP/GaP 610nm/Super Red

- (9)- GaAlAs 880nm
- (10)-GaAs/GaAs&GaAlAs/GaAs 940nm
- (A)- GaN 430nm/Blue
- (B)- InGaN 470nm/Blue
- (C)- InGaN 502nm/Ultra Green
- (D)- InGaN 523nm/Ultra Green

SURFACE MOUNT CHIP LED LAMPS

Part Number: 67-21SUGC

Typical Electro-Optical Characteristics◆ **CHARACTERISTICS DIAGRAMS**

FORWARD CURRENT VS. FORWARD VOLTAGE

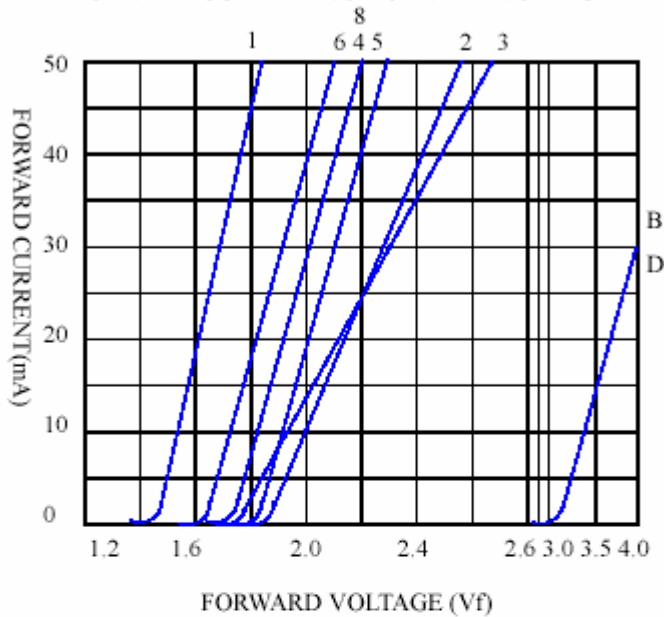

RELATIVE LUMINOUS INTENSITY VS. FORWARD CURRENT

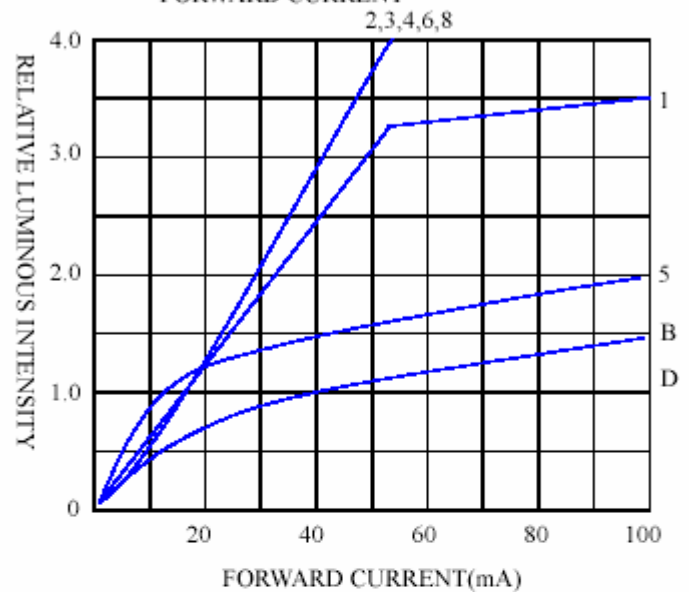

FORWARD CURRENT VS. AMBIENT TEMPERATURE

