

FESTOON LED BULB

Data Sheet

Top LED Bulb Series

AB-T36123XXXXXXXX-XX

Description:

These High Voltage LED Bulbs are specifically designed for electric equipment, indicator light switch and where a wide view angle.

The top view LED radiation pattern (120°) and high luminous intensity ensure that these devices are excellent for wide field of view outdoor applications where a wide viewing angle and readability in sunlight are essential.

High efficiency LED materials are used in this Bulb. Every lamp is made with an advanced optical grade epoxy offering superior high shock and high temperature resistance in outdoor applications.

Feature:

- High luminous output
- Free to differentiate anode and cathode(Bi-Polar)
- Solid-state Vibration resistant
- Saving power
- Long life

Option:

- 12V TO 14V DC
- Other industry standard base

A-BRIGHT

A-BRIGHT INDUSTRIAL CO.,LTD.

Part No.: AB-T36123W112VD41-CF

3 TOP LEDs Bulb

PACKAGE DIMENSIONS:

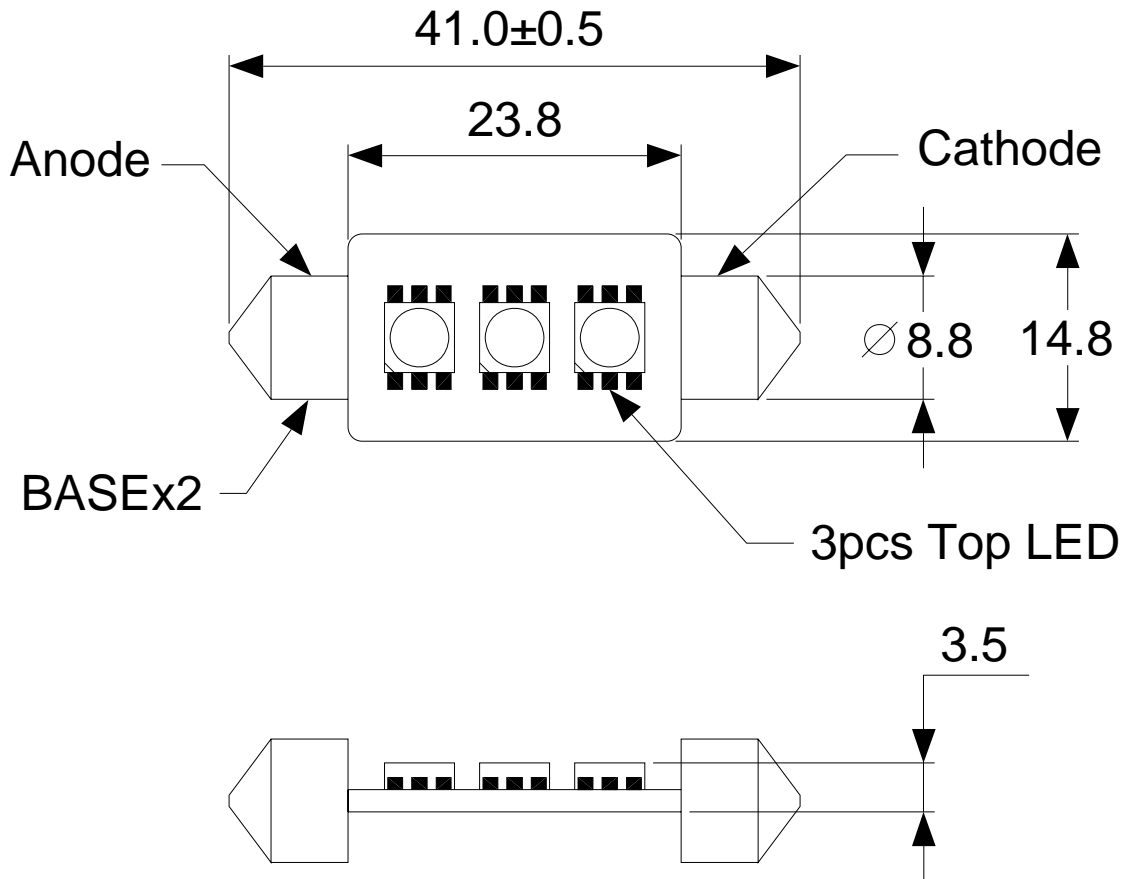

NOTE:

- 1.All dimensions are in millimeter.
- 2.All tolerance are ± 0.25 mm.

Part No.: AB-T36123W112VD41-CF

3 Top LEDs Bulb

FEATURE:

- SUPER LUMINOSITY WHITE LED (InGaN).
- WATER CLEAR PACKAGE.
- 3 CHIPS TOP VIEW LED.
- WIDE VIEWING ANGLE.
- ELECTRIC DC.

MATERIALS:

- LED LENS: UV RESISTENT EPOXY

ABSOLUTE MAXIMUM RATING: Ta = 25 °C

- PEAK OPERATE VOLTAGE..... 14 V
- OPERATING TEMPERATURE..... -25 TO +85°C
- STORAGE TEMPERATURE..... -35 TO +100°C
- LED BULB LIFE..... 20000 HOURS
(LUMINANCE REDUCES to 50%)

ABSOLUTE OPTICAL CHARACTERISTIC Ta= 25°C

PARAMETER		SYMBOL	MIN	TYP	MAX	UNIT
Operate Voltage		V	----	12	14	V
Luminous Intensity	V _{IN} = 12V DC	I _V	----	7500	----	mcd
Chromaticity Coordinates	V _{IN} = 12V DC	X	----	0.31	----	----
		Y	----	0.32	----	----
Forward Current	V _{IN} = 12V DC	I _F	----	65	----	mA
Viewing Angle		2θ _{1/2}	----	120	----	deg